



Construction

Close-coupled, single-impeller, centrifugal pumps; electric motor with extended shaft directly connected to the pump. Pump casing with suction and delivery connections with the same diameter and on the same axis (in-line).

Connections: Flanges PN 10, EN 1092-2.

Counterflanges (on request)

Sizes	Flanges
NR, NR4 40, 50, 65	Screwed flanges PN 16, EN 1092-1
NR4 100, NR4 125	Flanges for welding PN 10, EN 1092-1

5

Applications

For clean liquids, without abrasives, which are non-aggressive for the pump materials (contents of solids up to 0.2%).

For heating, conditioning, cooling and circulation plants.

For civil and industrial applications.

When low noise operation is required (n = 1450 rpm).

Operating conditions

Liquid temperature from -10 °C to +90 °C.

Ambient temperature up to 40 °C.

Total suction lift up to 7 m.

Maximum permissible working pressure up to 10 bar.

Continuous duty.

Materials

Component	Material
Pump casing Lantern bracket	Cast iron GJL 200 EN 1561
Impeller	Cast iron GJL 200 EN 1561 (Brass P-Cu Zn Pb 2 EN 1982 for NR-NR4 50, NR-NR4 50/200)
Shaft	Chrome-nickel steel AISI 303 for pumps up to 1.1 kW Chrome steel AISI 430 for pumps from 1.5 to 4 kW
Mecanical seal	Carbon - Ceramic - NBR
Counterflanges	Steel Fe 42 UNI 7070

Special features on request

- Other voltages. - Protection IP 55.

- Special mechanical seal. - Higher or lower liquid or ambient temperatures.

Motor

4-pole induction motor, 50 Hz (n = 1450 rpm).

NR4: three-phase 230/400 V ± 10% up to 3 kW;
400/690 V ± 10% for 4 kW.

NRM4: single-phase 230 V ± 10%.

2-pole induction motor, 50 Hz (n = 2900 rpm).

NR: three-phase 230/400 V ± 10% up to 3 kW;
400/690 V ± 10% from 4 to 18,5 kW.

NRM: single-phase 230 V ± 10%.

Insulation class F.

Protection IP 54.

Classification scheme IE2 for three-phase motor from 0,75 kW.

Constructed in accordance with EN 60034-1, EN 60034-30.

EN 60335-1, EN 60335-2-41.

Coverage chart

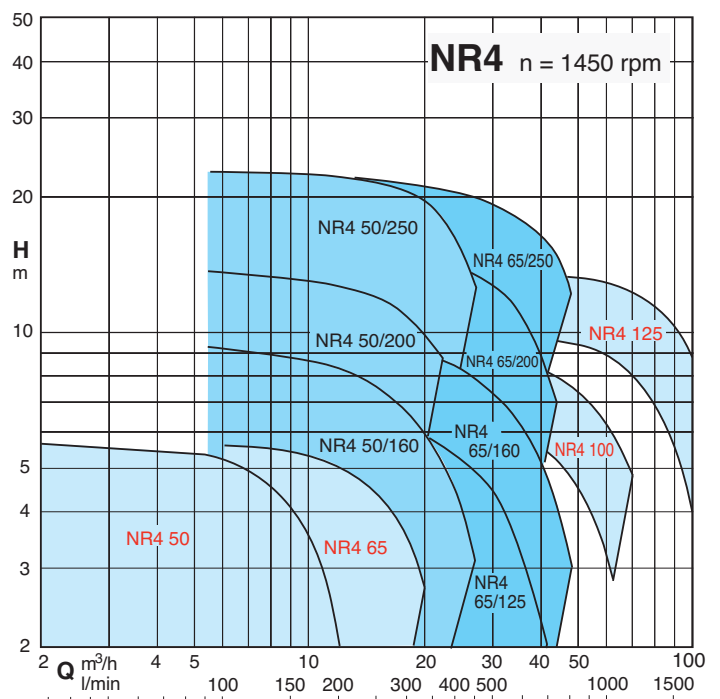
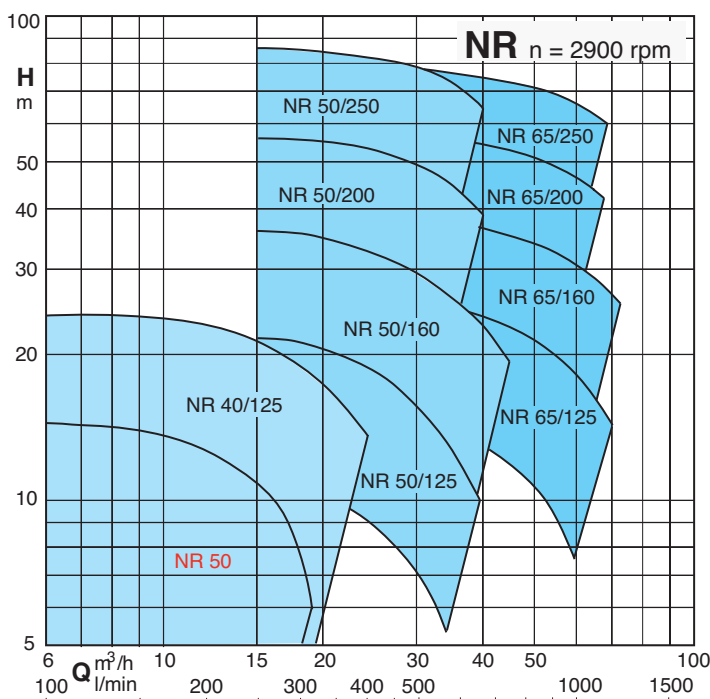

Characteristic curves $n \approx 2900$ rpm

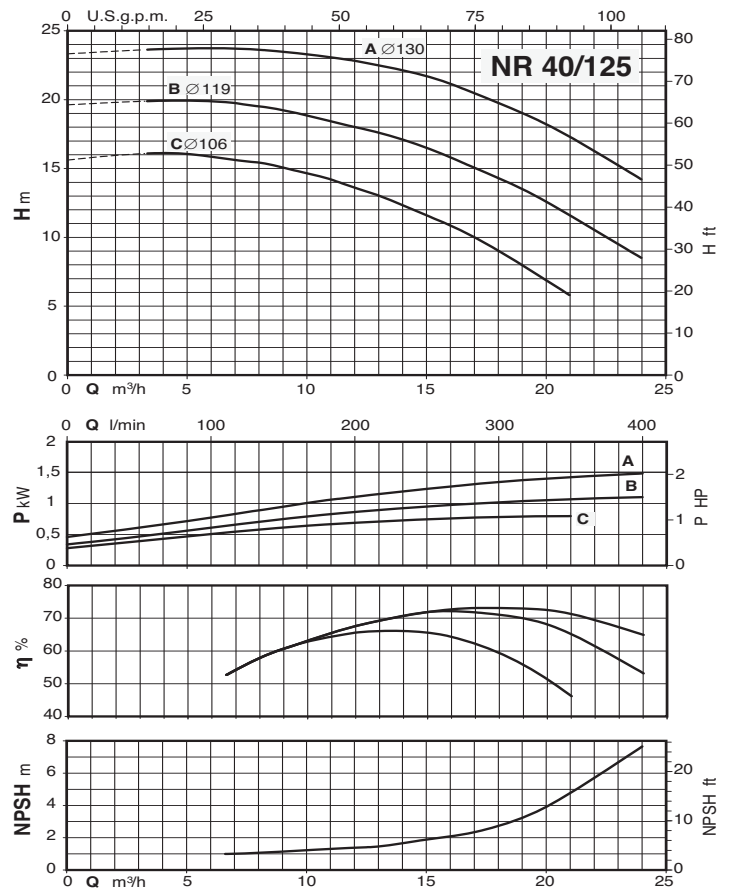
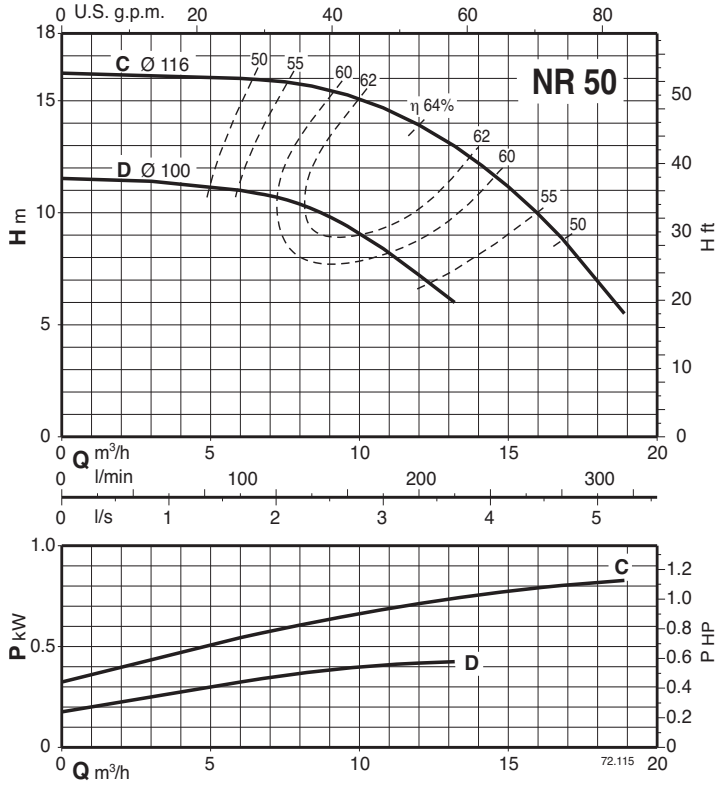

Characteristic curves $n \approx 2900$ rpm

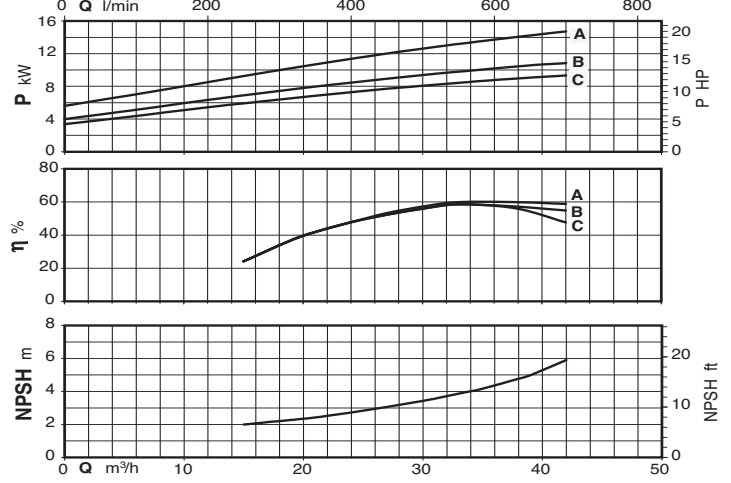
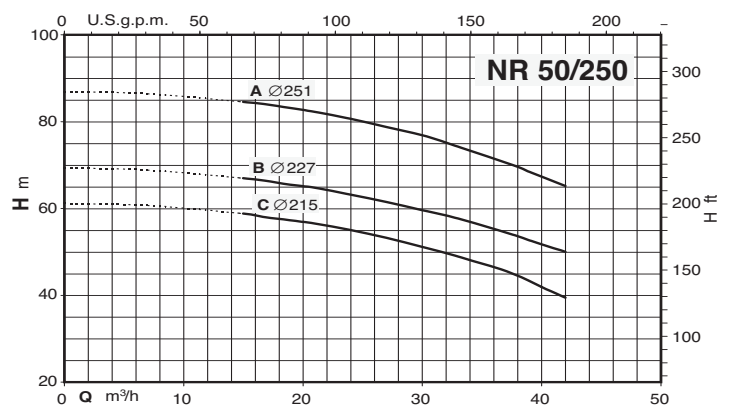
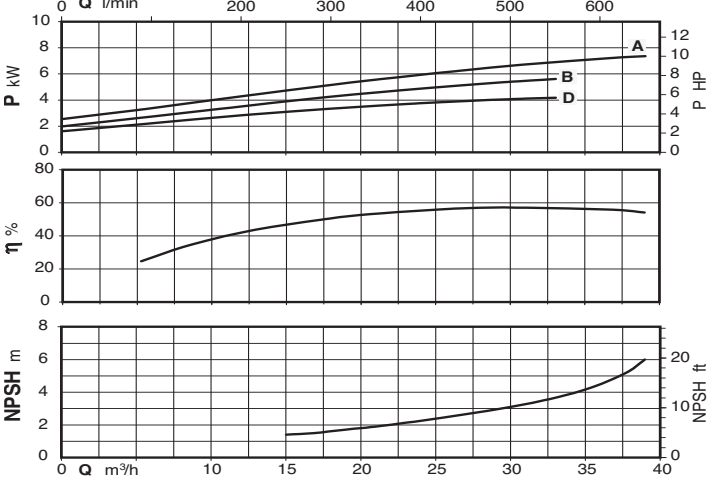
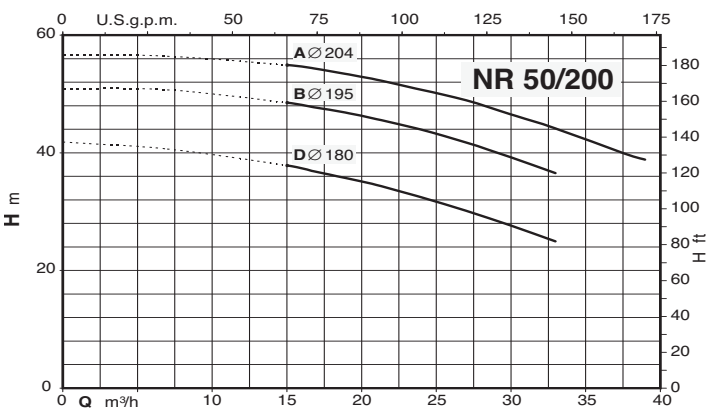
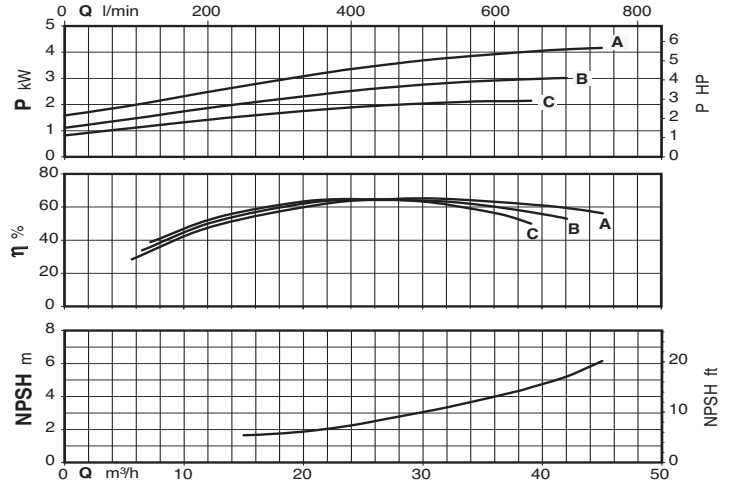
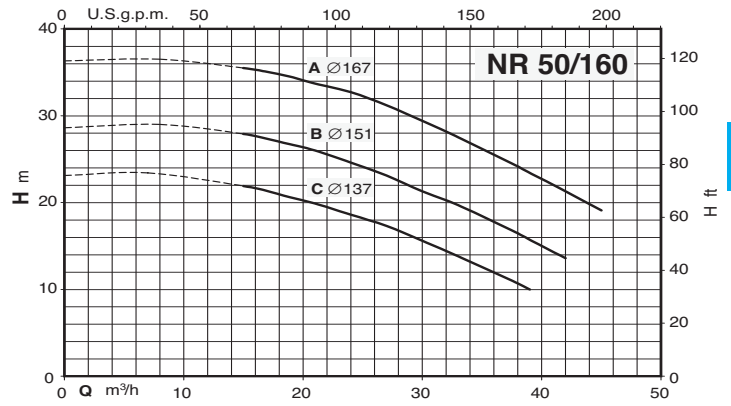
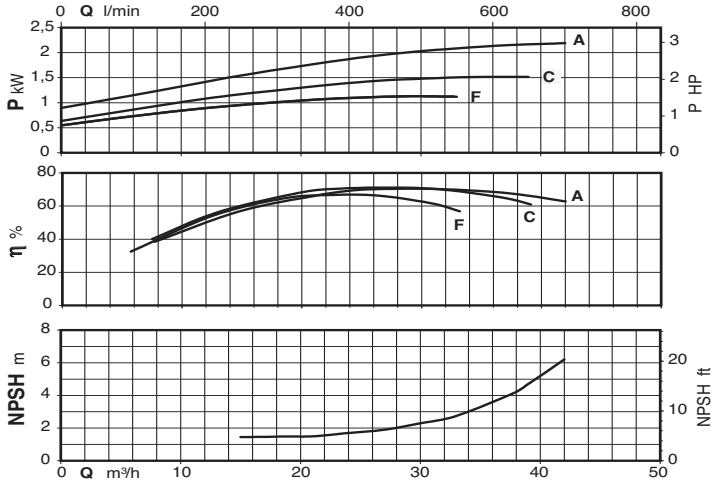
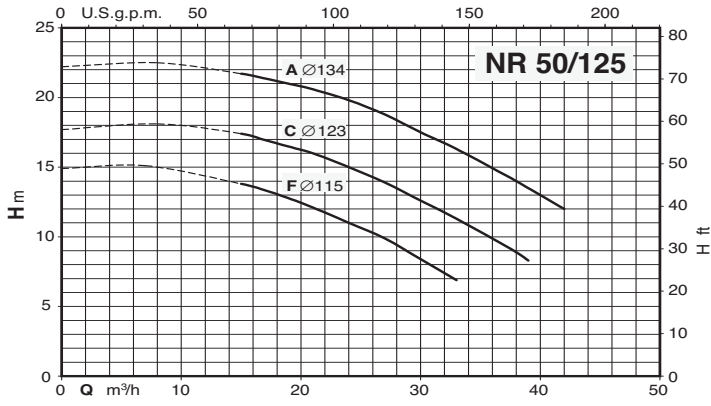

Characteristic curves $n \approx 2900$ rpm

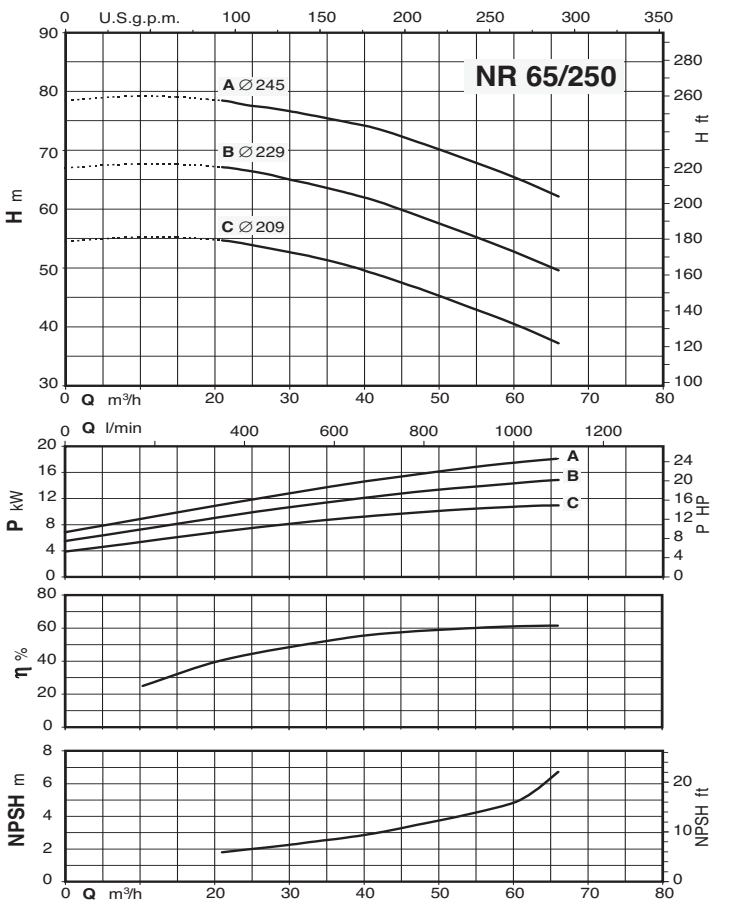
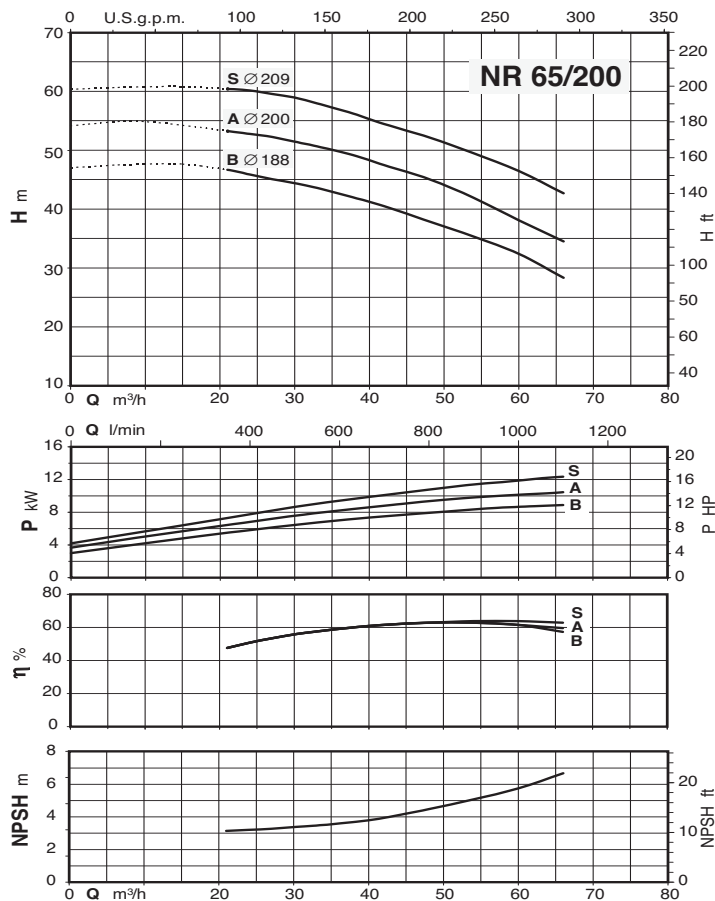
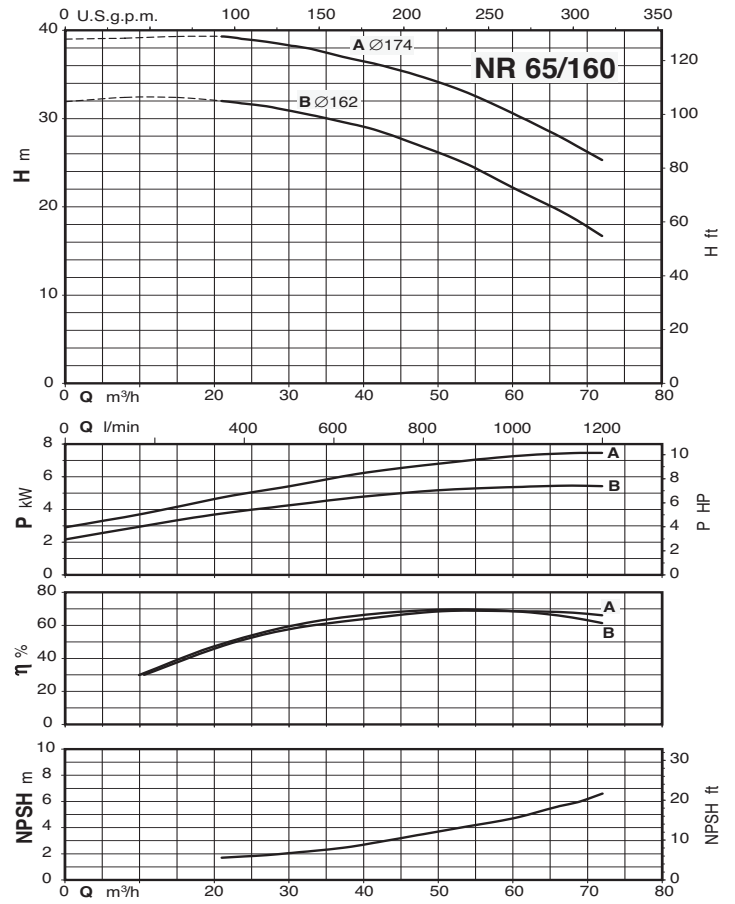
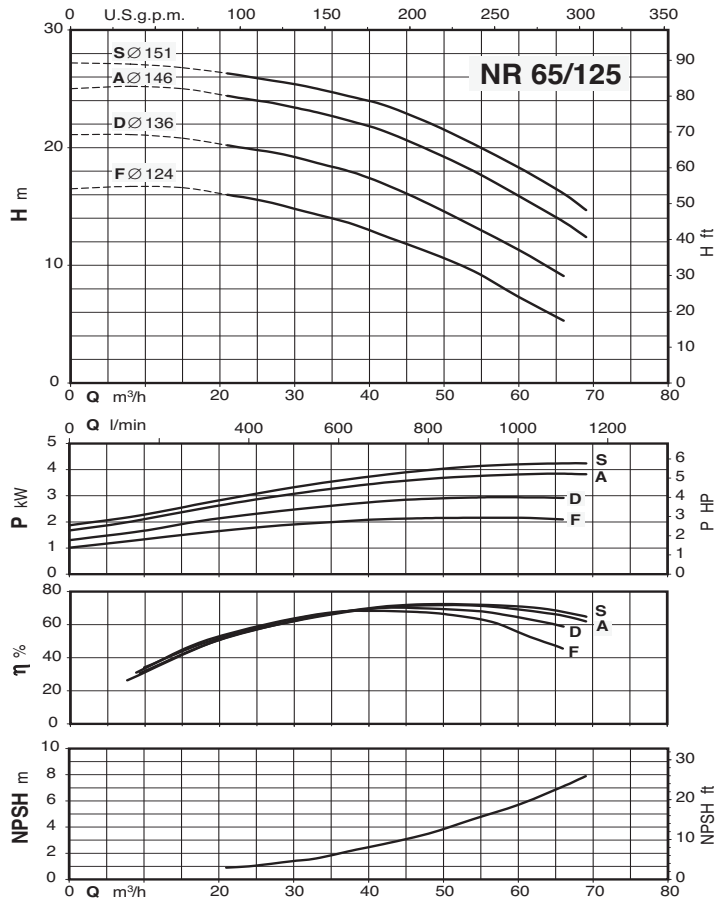

Characteristic curves $n \approx 1450$ rpm

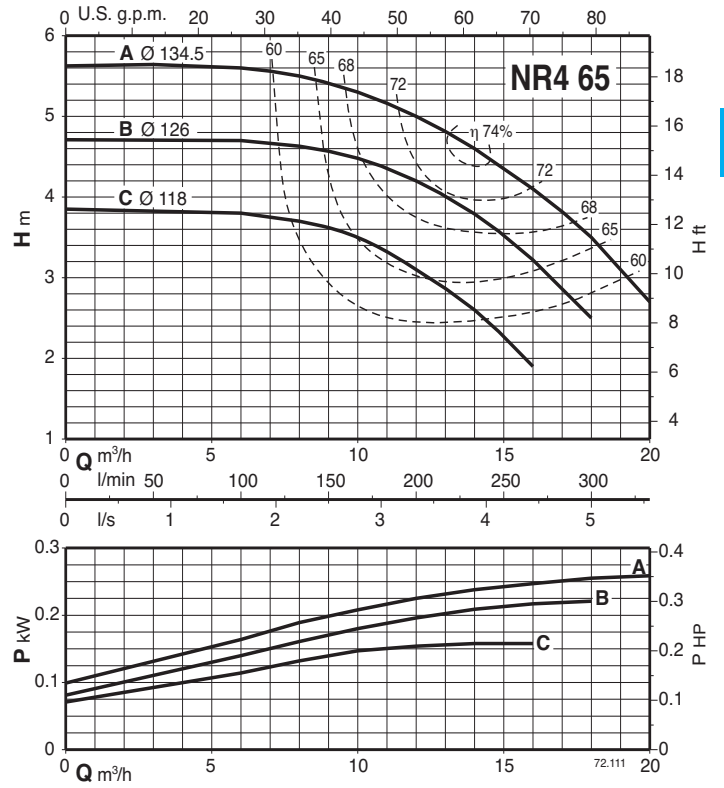
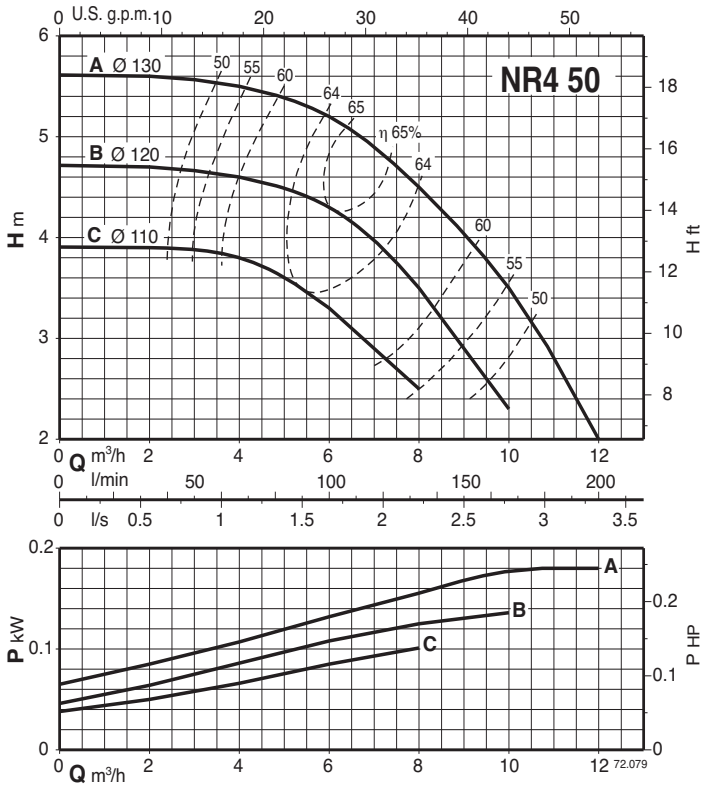

5

Characteristic curves $n \approx 1450$ rpm

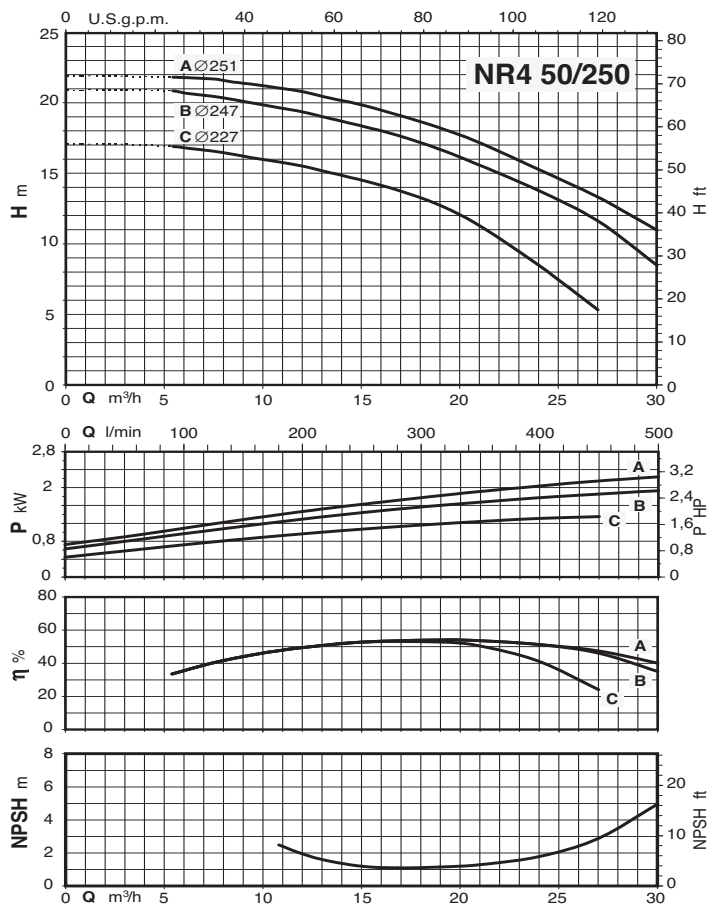
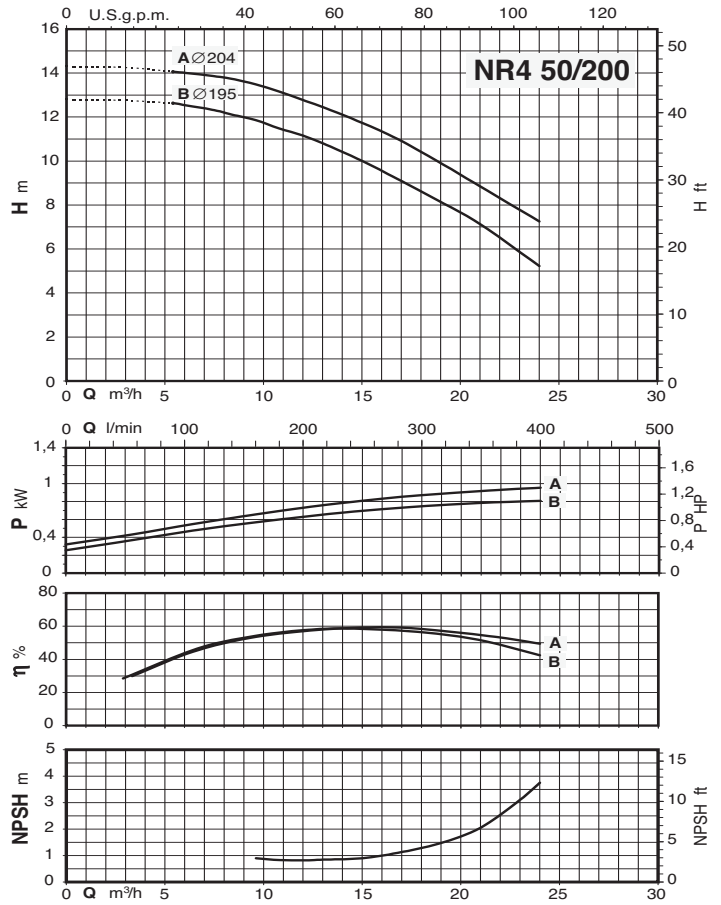
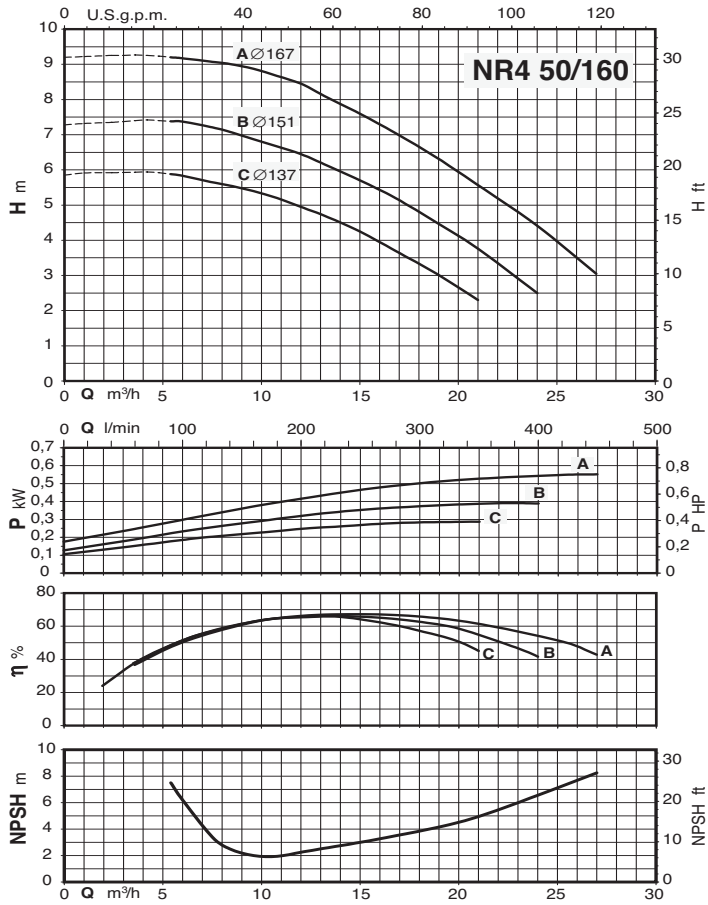

Characteristic curves $n \approx 1450$ rpm

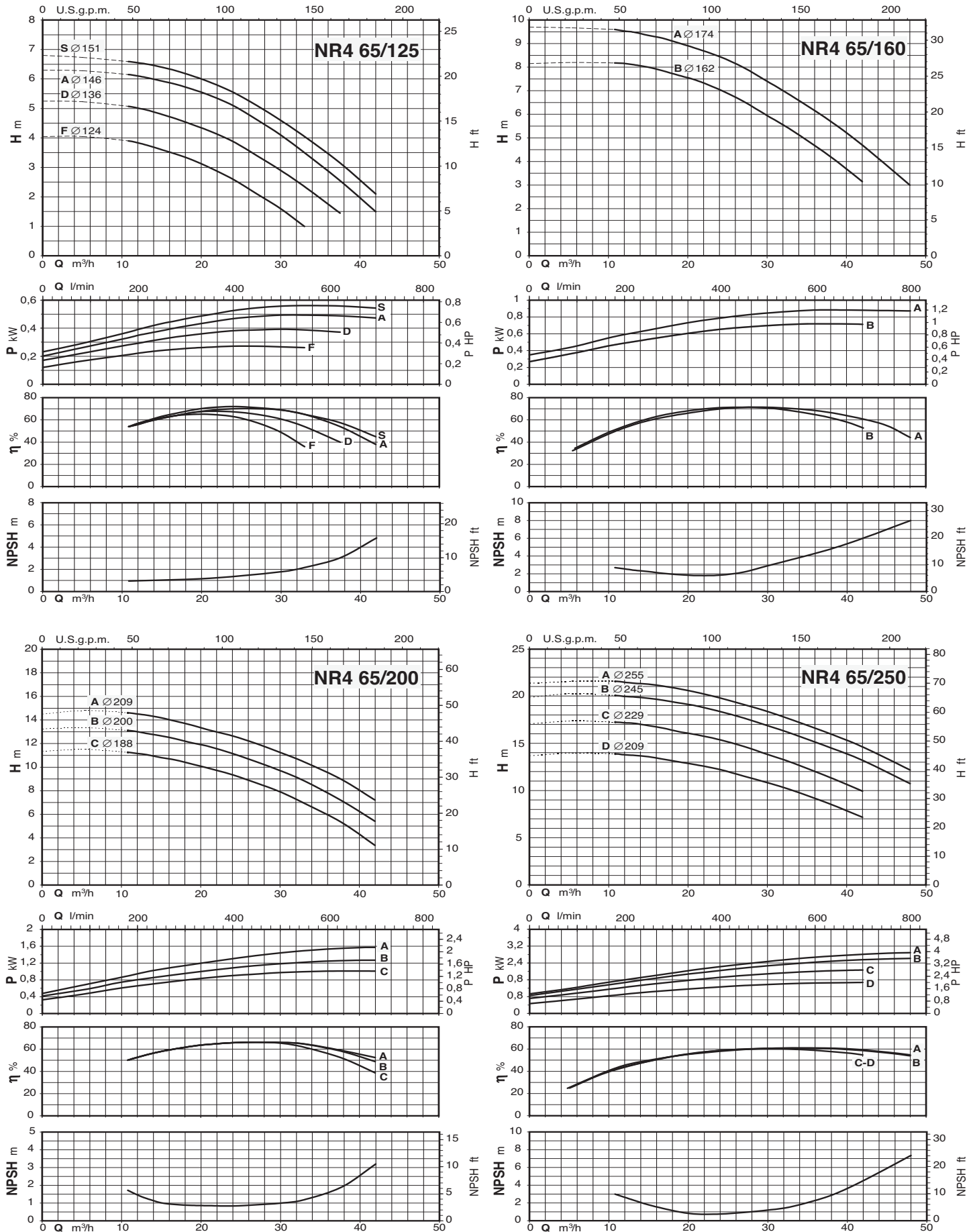

Characteristic curves $n \approx 1450$ rpm

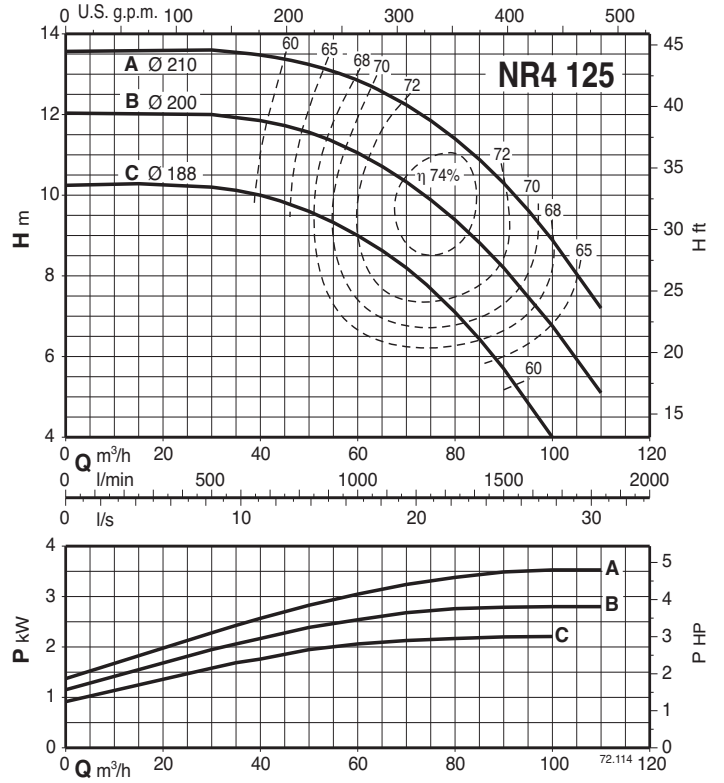
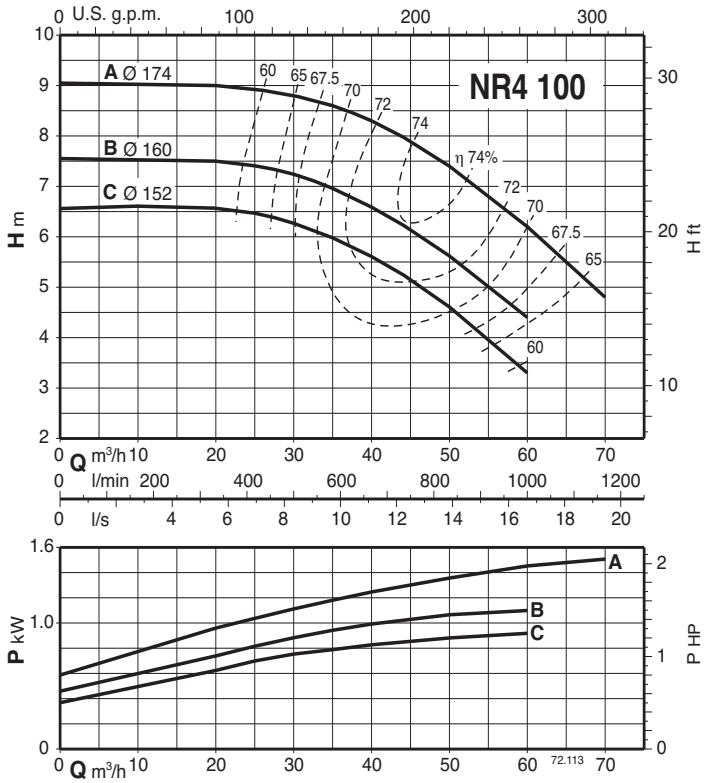

Dimensions and weights

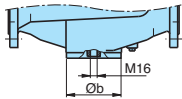
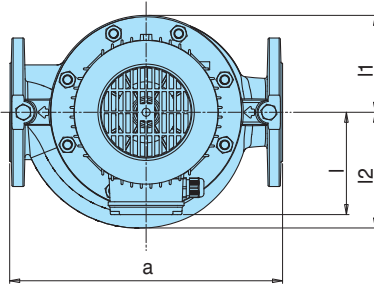
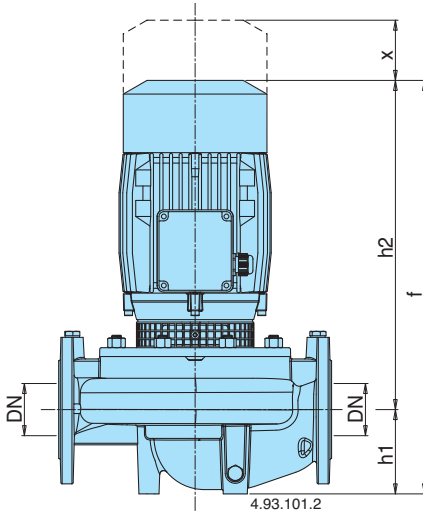

TYPE	mm										kg
	DN	a	f	h1	h2	Øb	l	l1	l2	x	
NR 50D/A-C/A	50	320	360	90	270	98	111	93	100	70	29,5-30
NR 40/125A-B-C	40	320	420	81	339	-	128	93	98	100	29,5-27,5-26,5
NR 50/125C-F	50	340	437	90	347	-	128	96	115	75	31,5-29,5
NR 50/125A/A	50	340	477	90	387	-	128	96	115	75	36,1
NR 50/160C/A	50	340	480	90	390	-	128	120	128	75	41,6
NR 50/160A/A-B/A	50	340	506	90	416	-	138	120	128	75	51,8-50,5
NR 50/200D/A	50	440	516	100	416	-	138	140	140	80	59,7
NR 50/200A/A-B/A	50	440	544	100	444	-	160	140	140	80	77,2-69,7
NR 50/250B/A-C/A	50	440	657	100	557	-	185	175	175	85	121-114
NR 50/250A/A	50	440	732	100	632	-	185	175	175	85	149,5
NR 65/125F/A	65	340	494	105	389	-	128	121	145	95	46
NR 65/125S/A-A/A-D/A	65	340	520	105	415	-	138	121	145	95	56,1-56,1-54,6
NR 65/160A/A-B/A	65	340	552	105	447	-	160	121	142	95	74-67,5
NR 65/200A/A-B/A	65	475	666	105	561	-	185	140	153	90	114-108
NR 65/200S/A	65	475	741	105	636	-	185	140	153	90	142,5
NR 65/250C/A	65	475	672	105	567	-	185	175	175	90	134
NR 65/250A/A-B/A	65	475	747	105	642	-	185	175	175	90	161-155

TYPE	mm										kg
	DN	a	f	h1	h2	Øb	l	l1	l2	x	
NR4 50A/A-B/A-C/A	50	320	360	90	270	98	111	93	100	70	24-24-24
NR4 65A/A-B/A-C/A	65	360	370	100	270	118	111	102	114	70	28-28-28
NR4 100B/A-C/A	100	500	523	150	373	162	128	153	173	105	59-59
NR4 100A/A	100	500	549	150	399	162	138	153	173	105	67
NR4 125C/A	125	600	589	170	419	194	138	172	195	120	91,5
NR4 125A/A-B/A	125	600	608	160	438	194	160	172	195	120	110-108
NR4 50/160A/A-B-C	50	340	440	90	350	-	128	120	128	75	37,5-35,5-33,5
NR4 50/200A/A-B/A	50	440	490	100	390	-	128	140	140	80	56
NR4 50/250B/A-C/A	50	440	516	100	416	-	138	175	175	85	80-77,5
NR4 50/250A/A	50	440	545	100	445	-	160	175	175	85	93,5
NR4 65/125S/A-A/A-D-F	65	340	454	105	349	-	128	121	145	95	
NR4 65/160A/A-B/A	65	340	497	105	392	-	128	121	142	95	42,7-42,5
NR4 65/200C/A	65	475	510	105	405	-	128	140	153	90	52
NR4 65/200A/A-B/A	65	475	536	105	431	-	138	140	153	90	64,5-60
NR4 65/250C/A-D/A	65	475	526	105	421	-	138	175	175	90	75,5-75,5
NR4 65/250A/A-B/A	65	475	555	105	450	-	160	175	175	90	98-85

Flanges PN 10, EN 1092-2

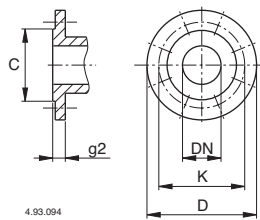

DN	mm				
	C	K	D	Holes N°	g2
50	99	125	165	4 19	20
65	118	145	185	4 19	20
80	132	160	200	8 19	22
100	156	180	220	8 19	24
125	184	210	250	8 19	24

Installation

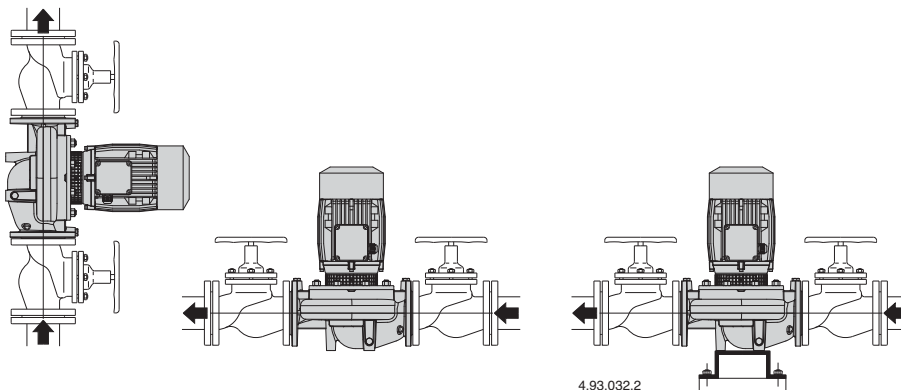

Features

NEW COMPACT DESIGN

A compact structure allows for simple installation even in confined spaces

A UNIQUE DESIGN

An innovative guard (patented) prevents contact with rotating parts, providing protection to the end user whilst allowing for inspection of the mechanical seal.

ADVANCED HYDRAULICS

Optimum impeller geometry provides maximum efficiency and excellent suction characteristics.

SILENT OPERATION

Specially designed fluid ducts provide very quiet operation

EXCEPTIONAL FLUID DYNAMICS

The fluid dynamics through the impeller and casing are designed to minimize losses and increase performance.

